



CLOCKMAKER'S ARBORS & POT CHUCKS

Arbors P/N 2090 through 2093
Gearcutting Arbors P/N 2094 through 2096
10mm "D" Pot Collets P/N 2103 through 2105

These arbors are not designed to be used on Sherline lathes, but rather are specifically suited to the types of lathes often used by jewelers and watch makers. Though highly accurate, these machines are often not very versatile.

The 3/4-16 arbors provide a way to mount a Sherline 3-jaw or 4-jaw chuck to this type of lathe. The 3/8-24 arbors allow

a 1/4" or 3/8" drill chuck to be mounted. The ability to mount these chucks adds a great deal of versatility to this type of special-purpose tool.

With use of a 8 mm adapter (P/N 1156) either of the 8 mm arbors can also be used on Sherline lathes, although the normal system for mounting chucks is recommended.

CLOCKMAKER'S ARBORS

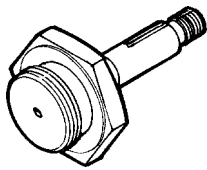

P/N 2090
Clockmaker's arbor
8 mm to 3/4"-16

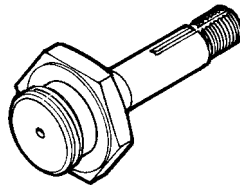

P/N 2091
Clockmaker's arbor
10 mm "D" to 3/4"-16

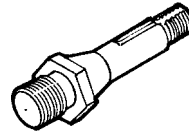

P/N 2092
Clockmaker's arbor
8 mm to 3/8"-24

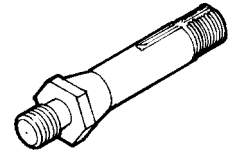

P/N 2093
Clockmaker's arbor
10 mm "D" to 3/8"-24

CLOCKMAKER'S GEARCUTTING ARBORS

The P/N 2094 gearcutting arbor with its #1 Morse taper can be used directly on your Sherline lathe or mill. The 2095 and 2096 arbors have a removable bushing that allows them to

accommodate geartooth cutters with two different center hole sizes. P/N 2096 can be used on a Sherline lathe or mill with the 8 mm collet adapter P/N 1156.

P/N 2094
Clockmaker's
gearcutting arbor
7 mm to Morse #1 taper

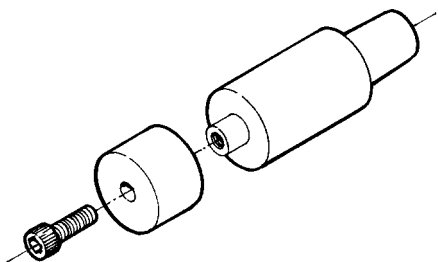

P/N 2095
Clockmaker's
gearcutting arbor
7 mm to 10 mm "D"
Collet

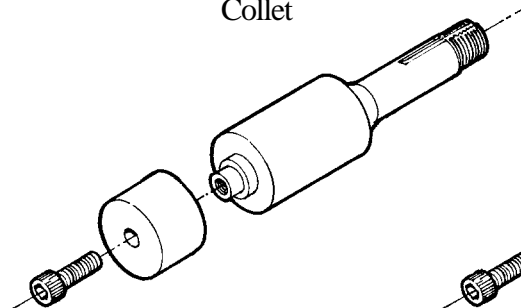

P/N 2096
Clockmaker's
gearcutting arbor
7 mm to 8 mm WW
Collet

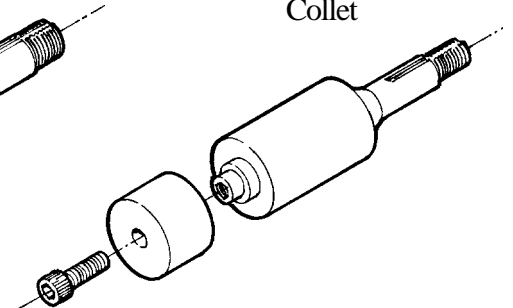

8 mm (WW) and 10 mm "D" COLLET POT CHUCKS

These collets fit a 10 mm spindle and are designed to hold larger and odd shaped pieces. The collets are split and have a 1/8" hole through. They are to be bored to fit your application. This is accomplished by tightening the collet in a lathe on the 1/8" pin supplied and boring the collet to the size needed. The depth of the bore shouldn't exceed .200" (5 mm). The diameter shouldn't exceed .625" (16 mm) on the 3/4" pot collet, .875" (22 mm) on the 1" pot collet or 1.125" (29 mm) on the 1-1/4" pot collet.

NOTE: Pot collets are designed to hold material only on the face end, not through the collet.

Part numbers for the collet pot chucks are as follows:

8 mm: (WW)

3/4"—P/N 2100

1"—P/N 2101

1-1/4"—P/N 2101

10 mm "D":

3/4"—P/N 2103

1"—2104

1-1/4"—2105

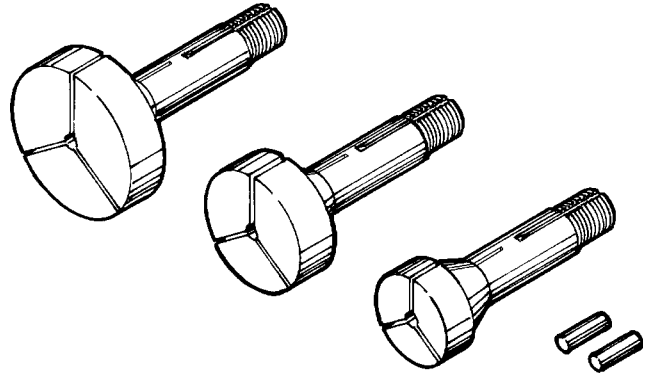

"Pot" or "step" collets and dowel pins. Sizes are 1-1/4", 1" and 3/4". They are shown with the 10 mm "D" shaft, but are also available with an 8 mm shaft which fits watchmaker's lathes sized for WW collets.